

SENSOR⁺ DIMMING SYSTEM

User Manual

Version 1.0.x



Copyright © Electronic Theatre Controls, Inc.
All Rights reserved.
Product information and specifications subject to change.
Part Number: 7150M1200-1.0.x Rev A
Released: June 2004

ETC[®], Emphasis[™], Expression[®], Insight[™], Imagine[™], Focus[™], Express[™], Unison[®], Obsession[®] II, ETCNet2[™], EDMX[™], Source Four[®], Revolution[™], Sensor[®], and WYSILink[™] are either registered trademarks or trademarks of Electronic Theatre Controls, Inc. in the United States and other countries.

The name WYSIWYG[™] is a trademark of CAST Lighting Limited.

Microsoft[®] and Windows[®] are registered trademarks of Microsoft Corporation in the United States and other countries.

All other trademarks, both marked and not marked, are the property of their respective owners.

Table of Contents

	Introduction	1
	Congratulatory.....	1
	Using this Manual	1
Chapter 1	Overview	3
	System Components	3
	Sensor+ Dimming System Features	6
Chapter 2	Basic Operation	7
	The CEM+ User Interface	7
	Sensor+ Connect Web Browser Interface	8
	Default Network Settings for Your Computer.	9
	CEM+ Basic Operation.	10
	The Main Menu	10
	About	11
	Login	13
	Presets.	14
	Panic	16
	Dimmer	17
	Rack (User only - no Guest access)	20
	Group (User only - no Guest access)	23
Chapter 3	Maintenance	25
Chapter 4	Service	27
	Contacting ETC about equipment problems	27
	Changing Installation Rack Modules	27
	Dimmer module circuit breakers	28
	CEM+ Fuses	29
	Reset/Test Ground Fault Interrupt (GFI) dimmer modules	29
	Troubleshooting	31
	Make a preliminary examination of your system.....	31
	If you cannot locate or correct the problem....	31



Appendix A	CEM+ Error Messages	33
Appendix B	Dimmer Curves	35
	Linear curve	35
	Modified linear curve	36
	Square law curve	36
	Modified Square law curve	37
	Sensor 2.0 curve	37
Appendix C	GFI Dimmer Test Sheet	39

Introduction

Congratulations...

on your purchase of the ETC Sensor[®]+ dimming system. Sensor+ continues ETC's tradition of providing the highest quality products for the entertainment lighting market. If you have questions regarding the operation or installation of your Sensor+ system, please contact ETC Technical Services at the office nearest you.

ETC Americas: Tel: +1 800 688 4116 (toll-free within USA)
Tel: +1 608 831 4116 (from outside USA)
Email: service@etconnect.com

ETC Asia: Tel: +852 2799 1220
Email: service@etcasia.com

ETC Europe: Tel: +44 (0)20 8896 1000
Email: service@etceurope.com

Using this Manual

This manual contains information on using the basic features of the CEM+ control module, the Sensor+ Connect browser interface, and basic maintenance and service procedures for your Sensor+ rack(s).

The following symbols are used in this manual to alert you to danger or important information.



Note: *Provides important information about your installation.*



CAUTION: *Alerts you to important information relating to equipment performance or reliability.*



WARNING: *RISK OF ELECTRIC SHOCK! Warns you when electricity may cause injury.*



WARNING: *Warns you when there is the possibility of other types of injury.*

Chapter 1

Overview

A Sensor+ dimming system controls lighting using EDMX™ control levels from a lighting control system on the ETCNet2™ network and/or DMX512 control levels from a lighting control system on the DMX network. The CEM+ can accept levels from EDMX and up to two DMX inputs. The configuration of your dimming system determines which input or combination of inputs will generate the output levels of your dimmers.

System Components

The Sensor+ system consists of Sensor+ installation racks, CEM+ control modules and various power control modules, generally referred to as “dimmers”, however a module may contain only a circuit breaker or a relay, or may contain no electronics at all.

Installation Racks

An installation rack, or “dimmer rack”, contains the dimmer modules and the CEM+ control module and all their associated electrical connections. The rack enclosure protects the dimming components with a key-locking door that contains an air filter. Cool air is pulled through the vents in the door, through the filter and over the dimmers. The hot air is expelled at the top of the rack.



CAUTION: *To ensure proper cooling of the rack, the door should not be left open and nothing should be placed on top of the rack during rack operation. Running your Sensor+ system with the door open exposes components to tampering and will allow dust contamination to accumulate, causing the system to overheat and shut down.*

There are four models of Sensor+ installation racks:

- **SR6+:** This rack contains six positions for dimmer modules and a CEM+ control module. Using dual dimmer modules gives this rack a maximum of 12 dimmable circuits.
- **SR12+:** This rack contains 12 positions for dimmer modules and a CEM+ control module. Using dual dimmer modules gives this rack a maximum of 24 dimmable circuits.
- **SR24+:** This rack contains 24 positions for dimmer modules and a CEM+ control module. Using dual dimmer modules gives this rack a maximum of 48 dimmable circuits.
- **SR48+:** This rack contains 48 positions for dimmer modules and a CEM+ control module. Using dual dimmer modules gives this rack a maximum of 96 dimmable circuits.

CEM+ Control Module

The CEM+ control module is required for Sensor+ dimming systems - the system will not function without a properly configured CEM+. This module contains the rack “brain” and it processes incoming control signals and transmits that information to the individual dimmers. It also monitors the system status and reports any errors. The CEM+ module can be used to configure the system. Configuration and error data can be accessed either locally at the CEM+ keypad, or by using the Sensor+ Connect web browser interface.

A configuration can support up to 16 CEM+ modules (or racks) in a *Group*. The Group configuration is stored in all CEM+ modules in that group. A single ETCNet2 network may

contain up to 64 Groups (1024 racks total).

The CEM+ has an Ethernet data input for incoming EDMX data and two DMX512 input ports (Port A and Port B). DMX Port B can be used as a DMX output port for one universe of DMX on the last logical rack in the Group. Data management is determined in the Group configuration.

The location of the CEM+ module is determined by the rack type:

- **SR6+, SR12+ and SR24+:** The CEM+ module is located at the bottom of the rack.
- **SR48+:** The CEM+ module is located in the middle of the rack, 24 positions from the top.



WARNING: *RISK OF ELECTRIC SHOCK! Do not apply power to a Sensor+ dimming system without a properly installed CEM+ module. A missing CEM+ exposes dangerous voltages and makes the system inoperable.*

Sensor Dimmer Modules

Sensor dimmer modules are installed in module positions in the installation racks. Each dimmer module may contain one or two dimmers (single or dual density) depending on the dimmer's current rating and rise time. All dimmer modules are protected by circuit breakers.

120V Sensor Modules		Max BTUs		Max BTUs	
AFM	Air Flow Module	0	D20AFJ	Dual 20A Dimmer Module - 500µS - Advanced Features - GFI - Japan	810
BC15	Dual 15A Branch Circuit Breaker Module	<10	D20AFN	Dual 20A Dimmer Module - 500µS - Neutral Connect	810
BC20	Dual 15A Branch Circuit Breaker Module	<10	D20DHR	Dual 20A Dimmer Module - 800µS - Advanced Features	688
CC15	Dual 15A Constant Circuit Breaker Module	<10	D20E	Dual 20A Dimmer Module - 500µS	810
CC20	Dual 20A Constant Circuit Breaker Module	<10	D20F	Single 20A Fluorescent Dimmer Module	<10
CC50	Single 50A Constant Circuit Breaker Module	<10	D20HR	Single 20A Dimmer Module - 800µS - Advanced Features	883
CC100	Half* 100A Constant Circuit Breaker Module	<10	D25AFD	Dual 25A Delta Dimmer Module - 400µS - Advanced Features	
D15	Dual 15A Dimmer Module - 350µS	380	D25D	Dual 25A Delta Dimmer Module - 400µS	
D15AF	Dual 15A Dimmer Module - 500µS - Advanced Features	474	D50AF	Single 50A Dimmer Module - 500µS - Advanced Features	808
D15AFG	Dual 15A Dimmer Module - 500µS - Advanced Features - GFI	474	D50AFD	Single 50A Delta Dimmer Module - 500µS	
D15AFN	Dual 15A Dimmer Module - 500µS - Neutral Connect	474	D50HR	Half* 50A Dimmer Module - 800µS - Advanced Features	1853
D15E	Dual 15A Dimmer Module - 500µS	474	D100AF	Half* 100A Dimmer Module - 500µS - Advanced Features	1521
D15F	Single 15A Fluorescent Dimmer Module	<10	L10	Dual 10A Low Wattage Dimmer Module	<10

120V Sensor Modules (Continued)		Max BTUs			Max BTUs
D15HR	Custom Module - Please Call	Call	L10F	Single 10A Low Wattage Fluorescent Dimmer Module	<10
D20	Dual 20A Dimmer Module - 350µS	522	R15AF	Dual 15A Relay Module - Advanced Features	<10
D20AF	Dual 20A Dimmer Module - 500µS - Advanced Features	810	R20AF	Dual 20A Relay Module - Advanced Features	<10
D20AFG	Dual 20A Dimmer Module - 500µS - Advanced Features - GFI	810	R20AFJ	Dual 20A Relay Module - Advanced Features - Japan	<10
230/240V Sensor Modules		Max BTUs			Max BTUs
AFM	Air Flow Module	0	ER15	Dual 15A Relay Module	<10
D25AFD	Dual 25A Delta Dimmer Module - 400µS - Advanced Features		ER15AF	Dual 15A Relay Module - Advanced Features	<10
D25D	Dual 25A Delta Dimmer Module - 400µS		ER25	Dual 25A Relay Module	<10
D50AFD	Single 50A Delta Dimmer Module - 500µS		ER25AF	Dual 25A Relay Module - Advanced Features	<10
ED15	Dual 3kW Dimmer Module - 225µS	474	HD15	Dual 3kW Dimmer Module - 240V	
ED15AF	Dual 3kW Dimmer Module - 400µS	474	HD15AF	Dual 3kW Dimmer Module - 240V - Advanced Features	
ED15N	Dual 3kW Dimmer Module - 225µS - Neutral Disconnect	474	HD25	Dual 5kW Dimmer Module - 240V	
ED25	Dual 5kW Dimmer Module - 250µS	810	HD25AF	Dual 5kW Dimmer Module - 240V - Advanced Features	
ED25AF	Dual 5kW Dimmer Module - 500µS - Advanced Features	810	HD25F	Single 25A Fluorescent Dimmer Module - 240V	<10
ED25N	Dual 5kW Dimmer Module - 350µS - Neutral Disconnect	810	HD50AF	Single 10kW Dimmer Module - 240V	
ED50AF	Single 10kW Dimmer Module - 500µS - Advanced Features		R15AF	Dual 15A Relay Module - Advanced Features	<10
EL5N	Dual 5A Low Wattage Dimmer Module				

*Half density modules occupy two module positions.



CAUTION: *Dimmer modules should only be removed by qualified personnel and must be replaced by modules of the same type, or by air flow modules, before restoring system power.*



WARNING: *RISK OF ELECTRIC SHOCK! Do not operate Sensor+ dimming systems with empty module positions. Open positions expose dangerous voltages and interfere with rack ventilation, causing the rack to overheat and shut down.*

Sensor+ Dimming System Features

Play back Presets from the CEM+

The CEM+ module provides 128 Presets that can be recorded from EDMX, DMX, or directly set levels. You can name, set fade times and playback priority for each Preset. You can assign Presets to any of four Rooms in the configuration. You can also have the Group play back a Preset in case of data loss.

Sensor+ Connect and WYSILink for Feedback

Sensor+ Connect duplicates the functions of the CEM+ module on a PC or Emphasis Server on the ETCNet2 network. The Web browser interface allows you to monitor rack activity, reconfigure dimmer curves, record and activate presets, load and backup configurations, and many other features.

Access to the CEM+ and Sensor+ Connect configuration features is protected by specific user levels and passwords to limit system-altering features to selected personnel, while allowing basic operational functions to a wider range of users.

WYSILink functions are also available on Link-enabled Emphasis Servers and WYSIWYG PCs. Presets can be recorded and activated from within the Link mode. In systems with Advanced Features racks, detailed information is displayed in the About Dimmer and About Rack displays, and you can perform load recording functions right from the Emphasis Server or PC.



Note: *Sensor+ Connect and Message logging are available on Emphasis Servers as a base functionality.*

Advanced Features

Sensor+ Advanced Features (AF) racks provide additional reporting features that help you to quickly learn the status of your dimming system and diagnose problems. AF dimmer modules indicate the presence of data and the relative output of power with LED indicators on the modules themselves. Much more information can be displayed on the CEM+ modules integral LCD display, or on a PC on the network running Sensor+ Connect in a Web browser or WYSIWYG with the WYSILink upgrade.

Advanced Features include the ability to record and monitor individual dimmer loads. Constant comparison of actual dimmer loads against the recorded value lets the system signal you when a load value changes. The change usually indicates a lamp has burned out or failed, allowing you to make an immediate replacement.

Dimmer Doubling (60Hz systems only)

ETC's Dimmer Doubler™ technology allows you to double the number of controllable circuits in your system without adding dimmer modules or running additional cable. The key to this system is the Dimmer Doubler two-fer.

The Dimmer Doubler two-fer is installed between a Sensor dimmer module and two ETC Source Four 77 volt fixtures. It splits the output of a single dimmer into two, separately-controlled outputs. You can then use an ETC control console to independently control the output of the two fixtures.



Note: *For more information on using Dimmer Doubler two-fers, see the Dimmer Doubler User Manual. For more information configuring your system for use with Dimmer Doubler two-fers, see the CEM+ Configuration Manual.*

Chapter 2

Basic Operation

This manual covers functions of the CEM+ and Sensor+ Connect that are available to the **Guest** and **User** login levels. **Power User** functions are described in the *CEM+ Configuration Manual*.

The CEM+ User Interface

You can access all the menus described in this chapter using the buttons on the face of the CEM+ module. Menus and messages are displayed on the integral 2x20 LCD display.

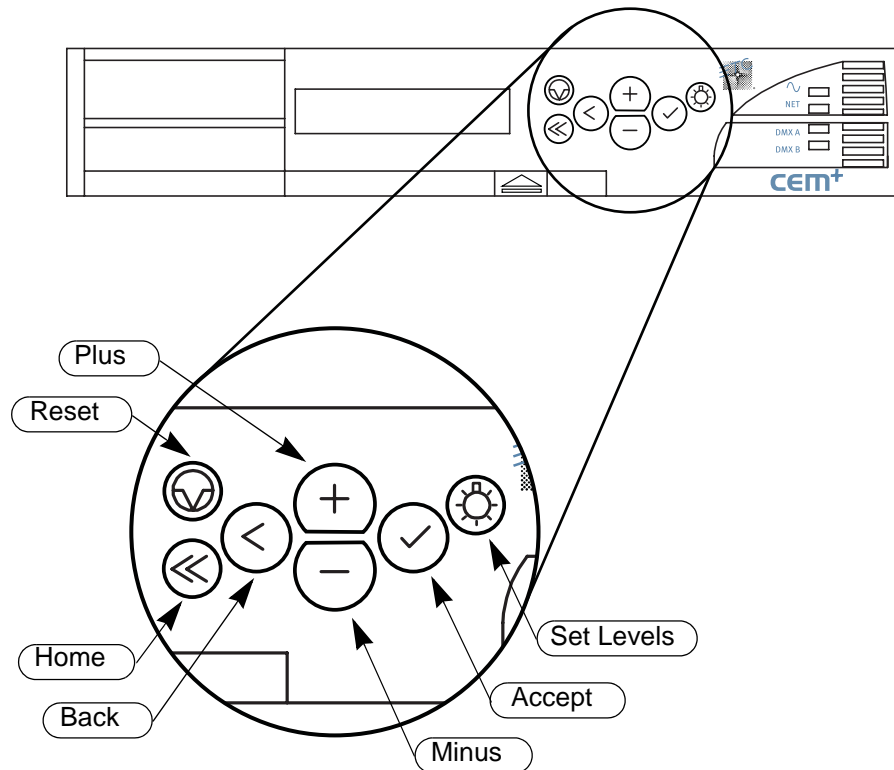

Figure 1: The CEM+ User Interface

Basic use of the CEM+ user interface:

- Use ⏪ to return to the main menu at any time.
- Use (+) and (-) to scroll through menus and through digits and letters in screens requiring user input.
- Use ✓ to accept settings and to view the error list.
- Use < to step back through menus.
- Use ⚙ to access the Set Levels menu.
- Use Ⓜ to reset the CEM+.

Sensor+ Connect Web Browser Interface

The Sensor+ Connect Web browser interface can be used instead of the direct buttons on the CEM+ module itself. You can use an Ethernet-capable PC connected to the ETCNet2 network and running Windows 2000 or XP and Internet Explorer 6 or later to browse into any of the Sensor+ racks on the network. If you are using an Emphasis Control System running version 1.8.0 software or better, there is a command in the WYSILink menu that automatically opens a browser window and connects to Sensor+ racks.

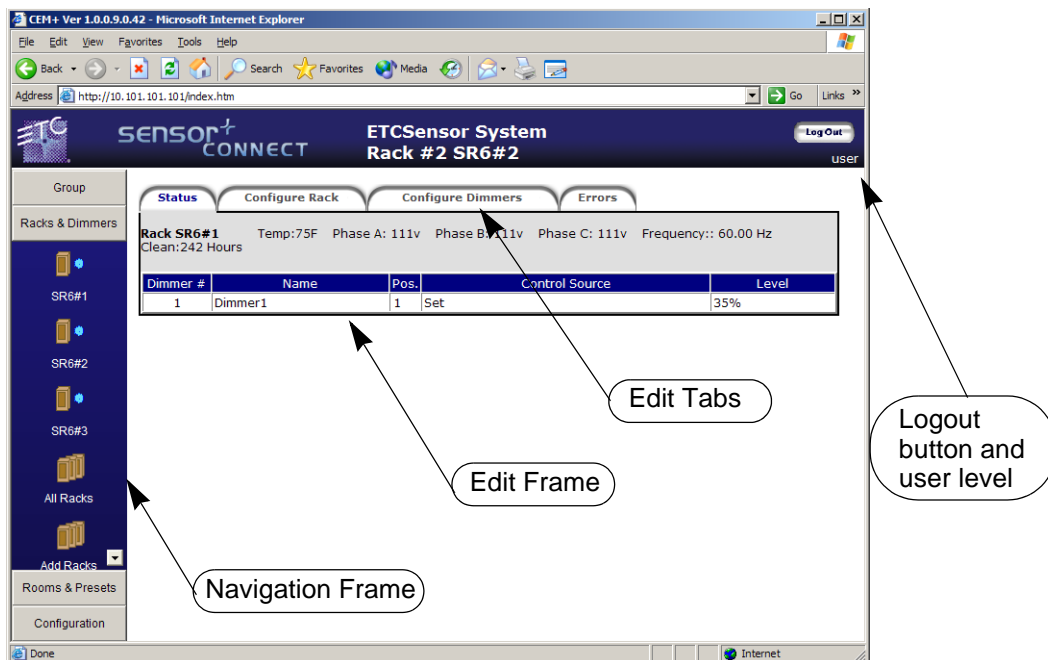

Figure 2: The Sensor+ Connect Web browser interface



Note: *The Emphasis Server network settings are the default ETC values and ready for immediate use. No configuration is required.*

You must set an IP address for any personal computer you plan to use on an ETCNet2 network. ETC recommends that the personal computer used on an ETCNet2 network is dedicated to that network so changes to network settings are kept to a minimum.



Note: *If the computer you wish to use is currently being used on a non-ETCNet2 network please consult your Network Administrator before changing the IP address, Subnet Mask or Gateway IP addresses.*

Default Network Settings for Your Computer

Prior to changing any Network settings on your personal computer please record the current settings in the following spaces below.

IP Address _____._____._____._____
Subnet Mask _____._____._____._____
Gateway IP _____._____._____._____

To use your personal computer on an ETCNet2 network that does not use a network router (i.e. hub and/or switch only), ETC recommends the following default settings:

IP Address 10.101.1.101
Subnet Mask 255.255.0.0
Gateway IP 10.101.1.101



Note: *If you have a network that does include a network router, you must set the Gateway IP address to the appropriate port on the router.*

Each additional computer on an ETCNet2 network must have it's own IP address which must be different from any other computer on the same ETCNet2 network. Select from the following default range of IP addresses for an additional personal computer on the network:

10.101.1.101	10.101.1.113
10.101.1.102	10.101.1.114
10.101.1.103	10.101.1.115
10.101.1.104	10.101.1.116
10.101.1.105	10.101.1.117
10.101.1.106	10.101.1.118
10.101.1.107	10.101.1.119
10.101.1.108	10.101.1.120
10.101.1.109	10.101.1.121
10.101.1.110	10.101.1.122
10.101.1.111	10.101.1.123
10.101.1.112	10.101.1.124

Browse into a CEM+ from Internet Explorer 6:

- Step 1: Open Internet Explorer 6.
- Step 2: Type "http://10.101.101.101" into the address box and press RETURN. Sensor+ Connect will open in the browser window if the CEM+ at the entered address is online.



Note: *10.101.101.101 is the default address for a CEM+ in the first rack of the first group. Your system may use a different addressing scheme. If that is the case, simply enter the IP address of one of the racks in the group you want to browse.*

CEM+ Basic Operation

The procedures covered in this section are available to users logged in as **Guest**, which requires no password or PIN, and **User**, which does require a password or PIN. Functions available to the **Power User** are described in the *CEM+ Configuration Manual*.

The Main Menu

The main menu is accessed using the (+) and (-) buttons on the CEM+ face panel. Each of the main menu items is described in the following pages. Each main menu item contains a number of sub-menus, each of which is illustrated in each section. To return to the CEM+ resting display (the display at the top of the diagram to the right), press (<<).

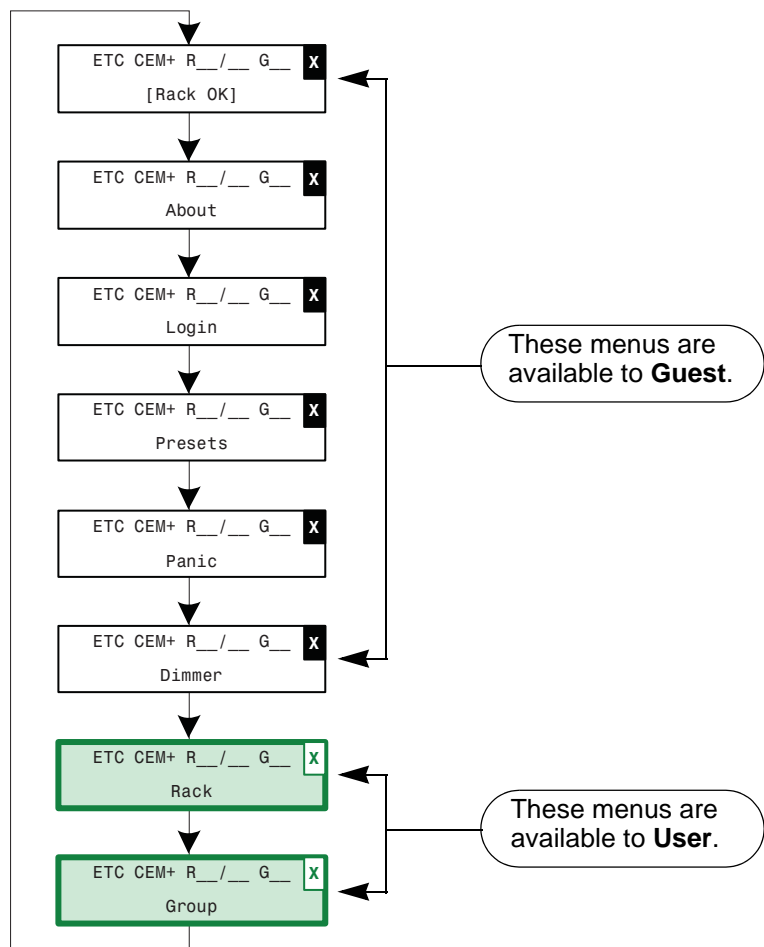

Figure 3: The main menu

About

The About menu provides status information about the dimmers, racks, network and Group. Everything in the About menu is accessible by the all users. No settings can be changed within the About menu, data can only be viewed.

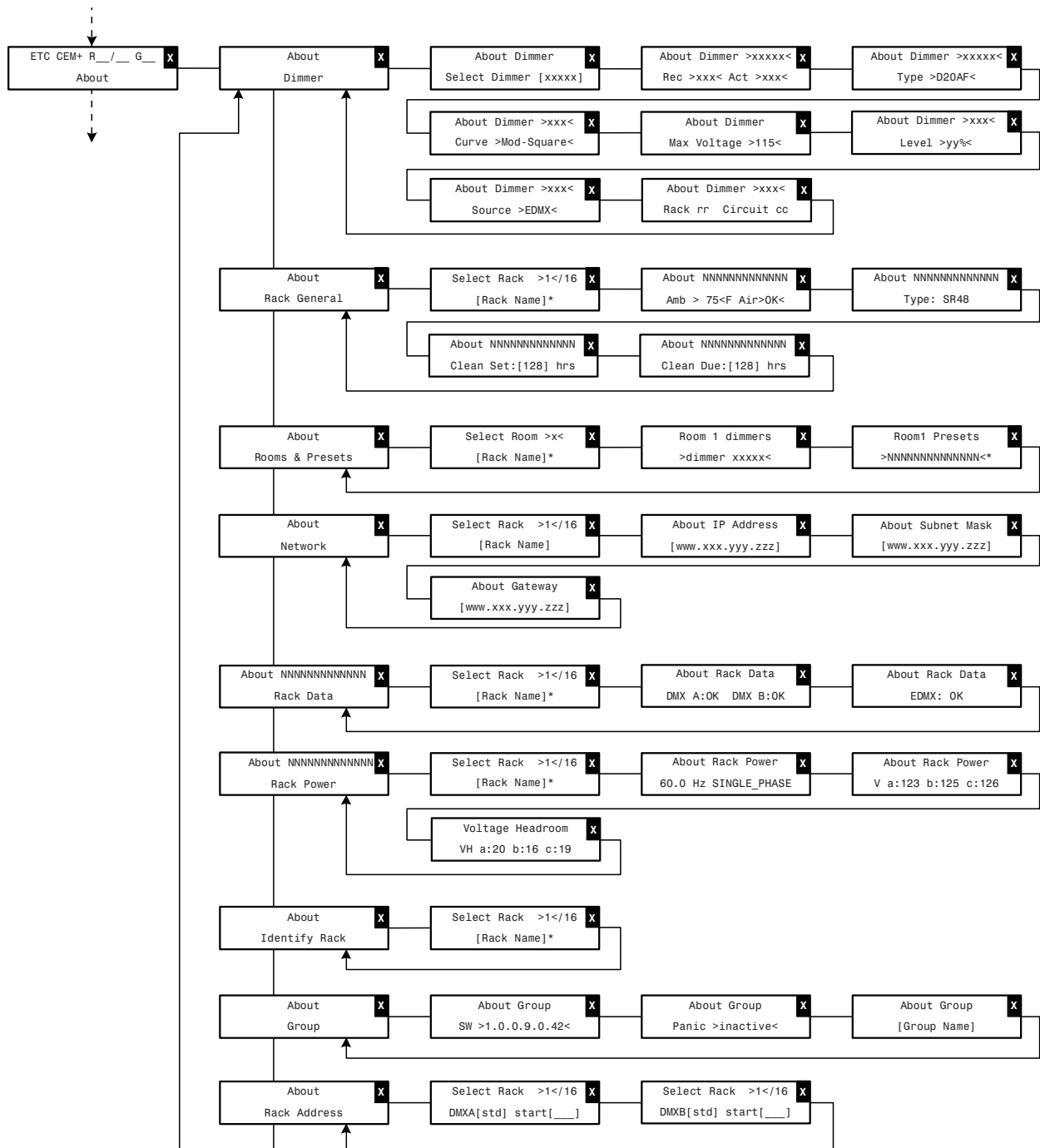

Figure 4: The About menu

Dimmer

About Dimmer provides information about a selected dimmer, including recorded and actual loads, the dimmer type, curve and maximum voltage. You can also view the current output level, the source of that level, and the dimmer's location.

Rack General

The Rack General menu provides the current ambient temperature and air flow status of the selected rack. It also displays the rack type, the air filter cleaning reminder setting, and the number of hours until the air filter cleaning reminder is due.

Rooms & Presets

About Rooms & Presets provides information on the room and preset settings for the rack you are currently browsing.

Network

About Network provides the network settings for the currently selected rack. You can view the settings for any rack in the Group.

Rack Data

About Rack Data provides status information for the DMX and EDMX inputs for any rack in the Group.

Rack Power

About Rack Power provides status information for the line feed power and the voltage headroom settings for any rack in the Group.

Identify Rack

Identify Rack flashes the beacon on the selected rack to identify it in the dimmer room.

Group

About Group provides the software version currently installed in the racks, the status of the Panic state and the name of the Group.

Rack Address

About Rack Address provides the DMX A and B starting addresses for each rack in the Group.

Login

The Login menu is where you enter the PIN number for the user level you want to access. **Guests** need no PIN to view the menu items accessible to them. **Users** will need to enter a four-digit PIN to gain access to features that are restricted. Use (+) and (-) to scroll the digits and use (✓) to enter the set digit.

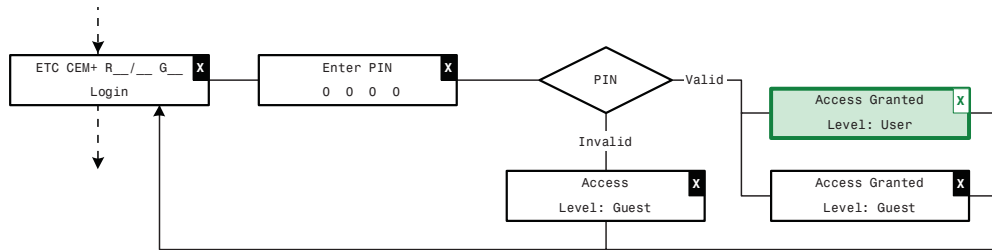

Figure 5: The Login menu

Presets

The Presets menus are used to activate and deactivate Presets at the rack. If you are logged in at the **User** level, you can also record and modify Presets from the CEM+.

There are four available Rooms and 128 available Presets in a single Group. A Room is a way of grouping dimmers - such as "Lobby" or "Auditorium". An individual Preset can only control dimmers assigned to the same Room. For example, a Preset with dimmers assigned to the Room named "Lobby" cannot also control dimmers in the Room "Auditorium".

Presets can also be assigned Priority. Priority is a function of ETCNet2 that defines how various sources of control interact with dimmers. The default priority for controllers on the network is 10. When controllers share the same priority level, a single dimmer assigned to those controllers will output the highest level it receives. If the controllers are at different priorities, the highest-priority controller (lowest priority number - a priority of 1 wins versus a priority 10) will win and the dimmer will output the level sent by that controller.

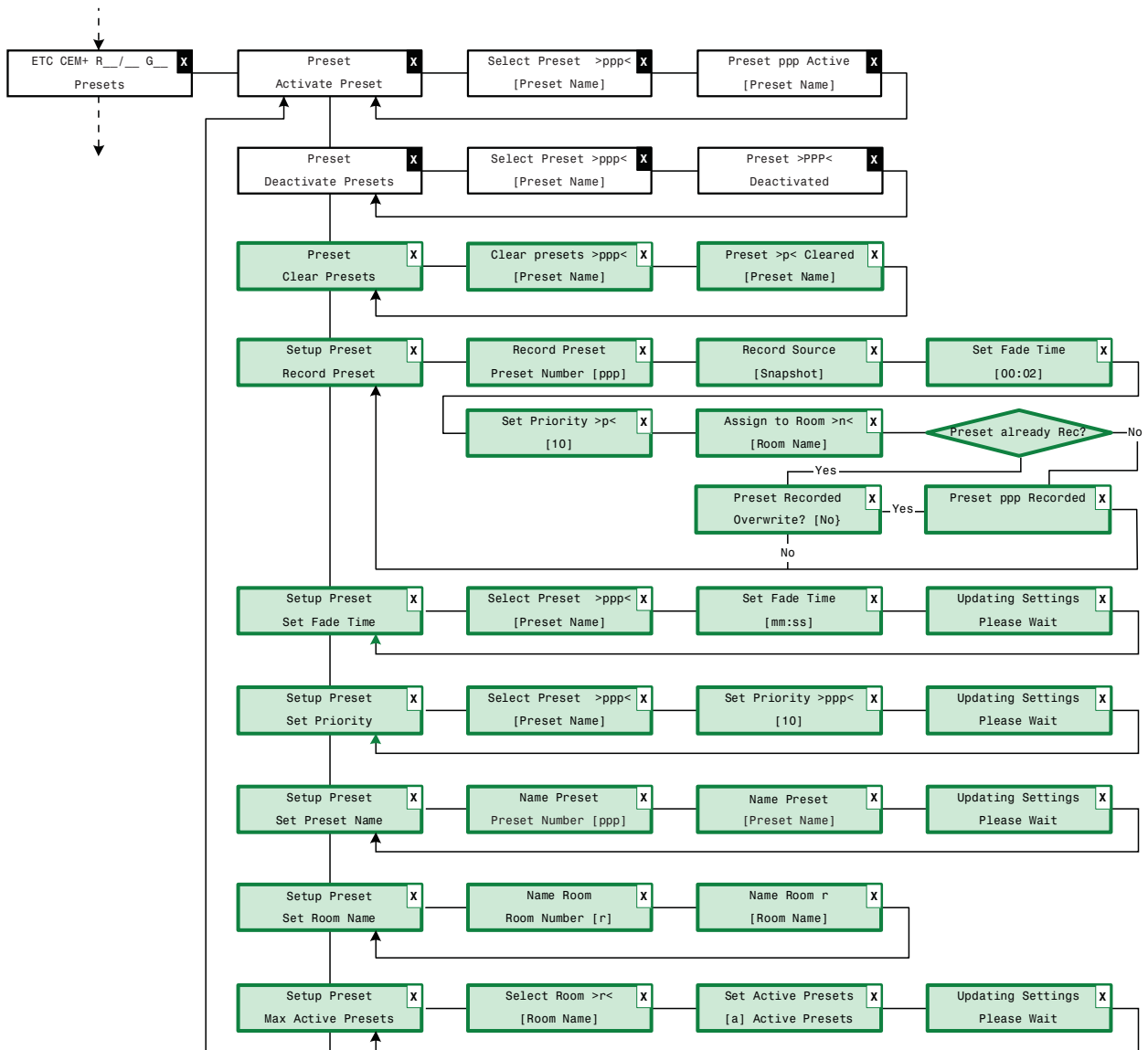

Figure 6: The Presets menu

Activate Preset

The Activate Preset menu allows you to activate a selected preset.

Deactivate Presets

The Deactivate Preset menu allows you to deactivate a selected preset.

Clear Presets (User only)

The Clear Presets menu allows a **User** to delete a selected preset.

Record Presets (User only)

The Record Presets menu allows a **User** to assign a preset number, and set the source for levels, the fade time and playback priority and the room. If the preset number is already recorded, you can record over it with the new settings, or if the preset is empty, you can record these settings to that selected number.

Set Fade Time (User only)

The Set Fade Time menu allows a **User** to update the fade time for a recorded preset.

Set Priority (User only)

The Set Priority menu allows a **User** to update the priority for a recorded preset.

Set Preset Name (User only)

The Set Preset Name menu allows a **User** to update the name of a recorded preset. Names are alphanumeric and can be up to 20 characters long (not all 20 characters will be visible on the LCD).

Set Room Name (User only)

The Set Room Name menu allows a **User** to set the name of a room.

Max Active Presets (User only)

The Max Active Presets menu allows a **User** to set the maximum number of active presets for a selected room.

Panic

The Panic menu allows a **Guest** to activate and deactivate the Panic look and allows a **User** to record and clear the Panic look.

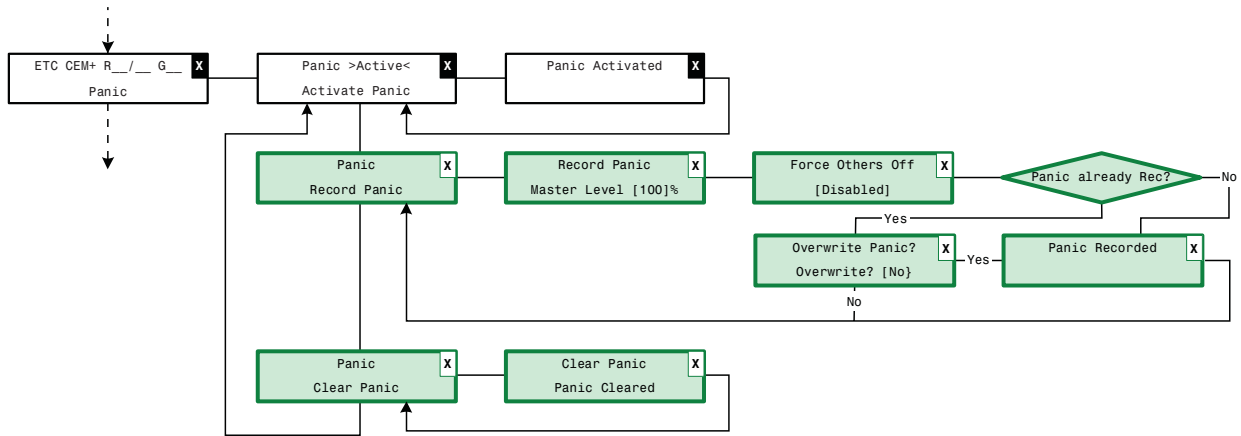

Figure 7: The Panic menu

Activate Panic

The Activate Panic menu toggles between “Activate” and “Deactivate”, depending on the status of the Panic look.

Record Panic (User only)

The Record Panic menu allows a **User** to record dimmers that currently have an output level at the Master Level, or greater, to the Panic look. You can set the Master Level to anything between 80% and 100%. When the Panic look is activated, the assigned dimmers will all output at the Master Level. You can also choose to set all other dimmers to turn off when panic is activated.

Clear Panic (User only)

The Clear Panic menu allows a **User** to clear the current Panic settings.

Dimmer

The Dimmer menu allows **Guest** access to setting and releasing dimmer levels, and allows **User** access to module setup items such as setting the module type, curve, name, firing mode and properties. The Dimmer menu also allows a **User** to perform a dimmer check.

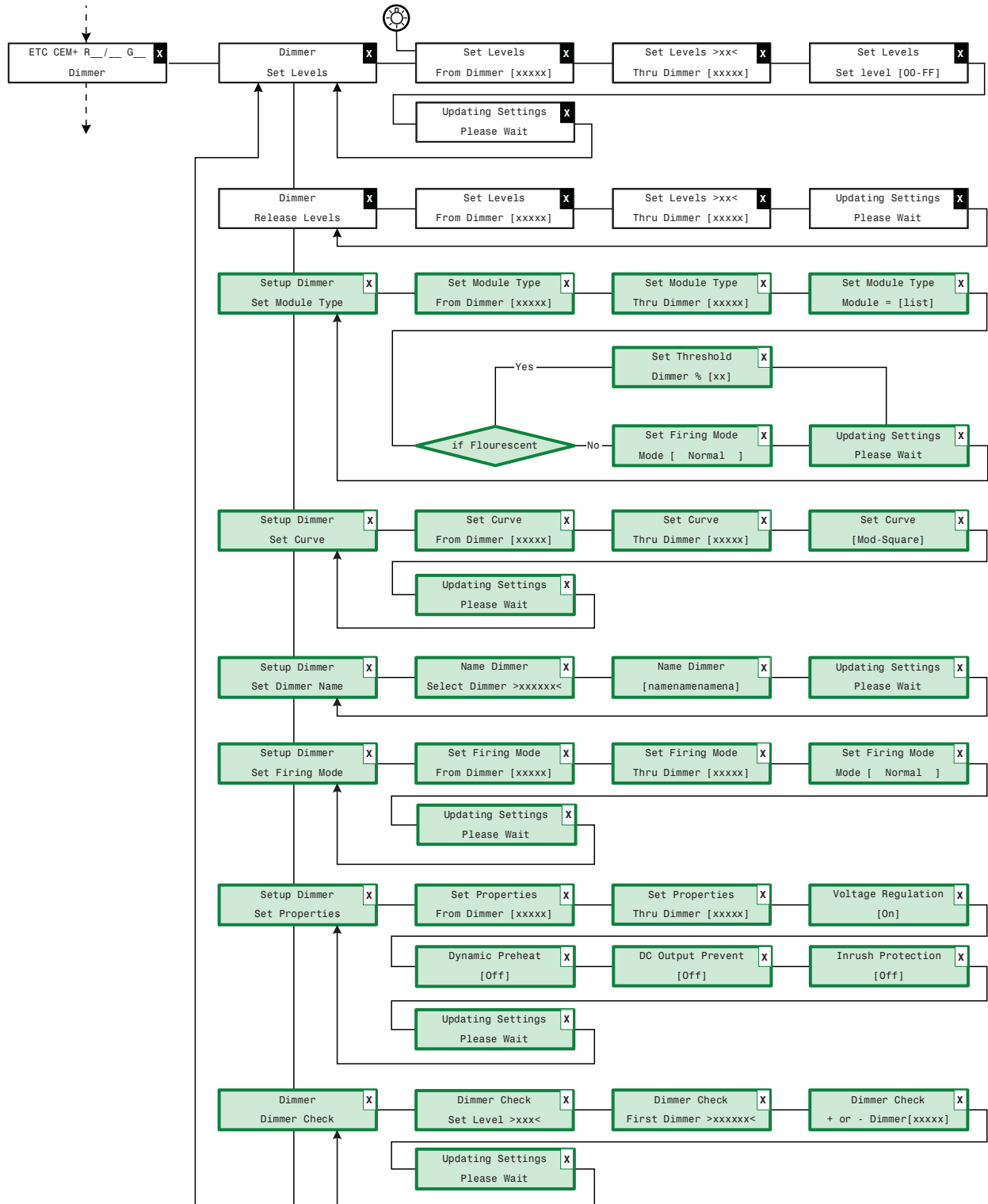



Figure 8: The Dimmer menu

Set Levels

The Set Levels menu allows you to set a dimmer or a range of dimmers to a specified level at the CEM+. Levels set here take priority over any other level inputs, such as control consoles and architectural control systems. Levels set here do not take priority over levels generated by an active Panic look.

The  button on the CEM+ face panel accesses this menu directly.

Release Levels

The Release Levels menu allows you to release the level of a dimmer or a range of dimmers. Once released, those dimmers are available to other control inputs.

Set Module Type (User only)

The Set Module Type menu allows a **User** to set a dimmer or range of dimmers to a specific module type and firing mode. If the module is set to “Fluorescent”, you also set the threshold in this menu. Threshold is the control level that must be present for the fluorescent dimmer to output voltage based on the selected curve.

Set Curve (User only)

The Set Curve menu allows a **User** to set a dimmer or a range of dimmers to a specific curve. A dimmer curve is a mathematical function that maps control levels to RMS output voltage. Curves are scaled from the minimum voltage to the maximum voltage (settings that are not available to the **User** login). The CEM+ supports the following curves: Square, Mod Square, Linear, Mod Linear, Sensor 2.0. See [Dimmer Curves, page 35](#), for more information.

Set Dimmer Name (User only)

The Set Name menu allows a **User** to name a dimmer. Names are alphanumeric and can be up to 20 characters long (not all 20 characters will be visible on the LCD).

Set Firing Mode (User only)

The Set Firing Mode menu allows a **User** to set a dimmer or a range of dimmers to a specific firing mode. Available modes include Normal, Off, Switched, Fluorescent and DD (Dimmer Doubled).

- Off: turns the dimmer off.
- Normal: operates as a standard incandescent dimmer.
- Switched: dimmers output unregulated AC voltage when the control level is above the threshold level.
- DD (Dimmer Doubled): dimmer operates as two controllable circuits. See [Dimmer Doubling \(60Hz systems only\), page 6](#).



Note: *Changing the dimmer firing mode will cause a change to default settings for curve, minimum voltage, maximum voltage, threshold and regulation. Whenever a dimmer mode is set the defaults for that mode will be applied to the other dimmer properties.*

Set Properties (User only)

The Set Properties menu allows a **User** to set Voltage Regulation, Dynamic Preheat, DC Output Prevent and Inrush Settings for a dimmer or range of dimmers.

- Voltage Regulation: when enabled, the dimmer will regulate to the desired output voltage. When disabled, the dimmer will be set to a constant firing time based on the control level. This setting defaults “on”. The ability to disable regulation is sometimes

useful when dimming non-tungsten loads.

- **Dynamic Preheat:** this setting allows quick blackouts on dimmers that are set to preheat. Preheat settings are not available to the **User** level login.
- **DC Output Prevent:** this setting offers protection on selected dimmers for loads that are sensitive to DC buildup, which can occur under certain conditions when positive and negative half-cycles become uneven.
- **Inrush Protection:** this setting protects against large voltage increases in a single AC cycle. This protection is useful for high-wattage loads that may cause nuisance tripping of circuit breakers and to limit peak currents in wiring and switchgear. This protection is particularly useful on RCD/GFCI protected circuits. Settings for inrush protection include: Instant, 100mS (for loads up to 10A), 300mS (for loads up to 25A) and 500mS (for loads of 50 or 100A).

Dimmer Check (User only)

The Dimmer Check menu allows a **User** to set an output level and then step through dimmers at a selected starting point.

Rack (User only - no Guest access)

The Rack menu includes menus for setting the rack name and patch settings. The Rack menu is available only to those logged in at the **User** level.

Set Rack Name

The Set Rack Name menu allows a **User** to set the name of the rack you are currently browsing. Names are alphanumeric and can be up to 20 characters long (not all 20 characters will be visible on the LCD).

Set Patch Mode

The Set Patch Mode menu allows a **User** to set the patch mode for a selected rack. The patch mode can be set to "Standard" or "Advanced".

Set Patch

The Set Patch menu allows a **User** to enable and disable DMX and EDMX inputs, set their priority and create the patch for those input ports. The choices that appear are dependent on the patch mode set in the previous menu.

In Standard patching, you set the first dimmer number to be addressed by a selected DMX or EDMX address and the length of the DMX or EDMX stream to be used for that port - for example: setting the first dimmer to 1 and the DMX Start to 101 and the DMX Length to 24 will cause dimmer #1 to respond to input levels on DMX channel 101, dimmer #2 to respond to DMX 102, and so on until dimmer #24.

In Advanced patching, you set a discrete DMX or EDMX address for each dimmer number.

Data Loss Behavior (User only)

Data Loss Behavior can be set independently for each input port (DMX A, DMX B and EDMX) in each rack in the Group. Data loss behavior options are: Hold Last Look, Wait & Fade Out and Generate Event. When data is restored, the source look will fade in at a 2-second rate.

- Hold Last Look: the CEM+ will hold any active dimmers at whatever levels they were receiving when the data was lost. The dimmers will remain on until data is restored or the CEM+ is reset.
- Wait & Fade: the CEM+ will hold any active dimmers at whatever levels they were receiving when the data was lost for a user-defined amount of time and then fade those dimmers to zero (or to the levels generated by the next highest priority source) in a user-defined fade time. The maximum wait and fade time is 60:59 minutes.
- Crossfade To: this setting will play back Preset 128 when data is lost. The default fade time for Preset 128 is 2 seconds. If this time is changed, both sides of the crossfade (the fade into Preset 128 and the fade back into restored data) will use the new time.

Set Network (User only)

Set Network allows a **User** to enable or disable the network, enable or disable BootP (defaults to disabled) and set the network addressing for a selected rack.

Set First Dimmer (User only)

Set First Dimmer allows a **User** to set the first dimmer number in a selected rack. For example, in a two SR48 rack Group, Rack 1 can be set with a First Dimmer of 1, and Rack 2 can be set with a First Dimmer of 97.

Set Temp Alarm (User only)

The Temp Alarm is used to generate a warning when the ambient temperature monitored by the rack exceeds a user-defined level. Use the Set Temp Alarm menu to set that level for the selected rack.

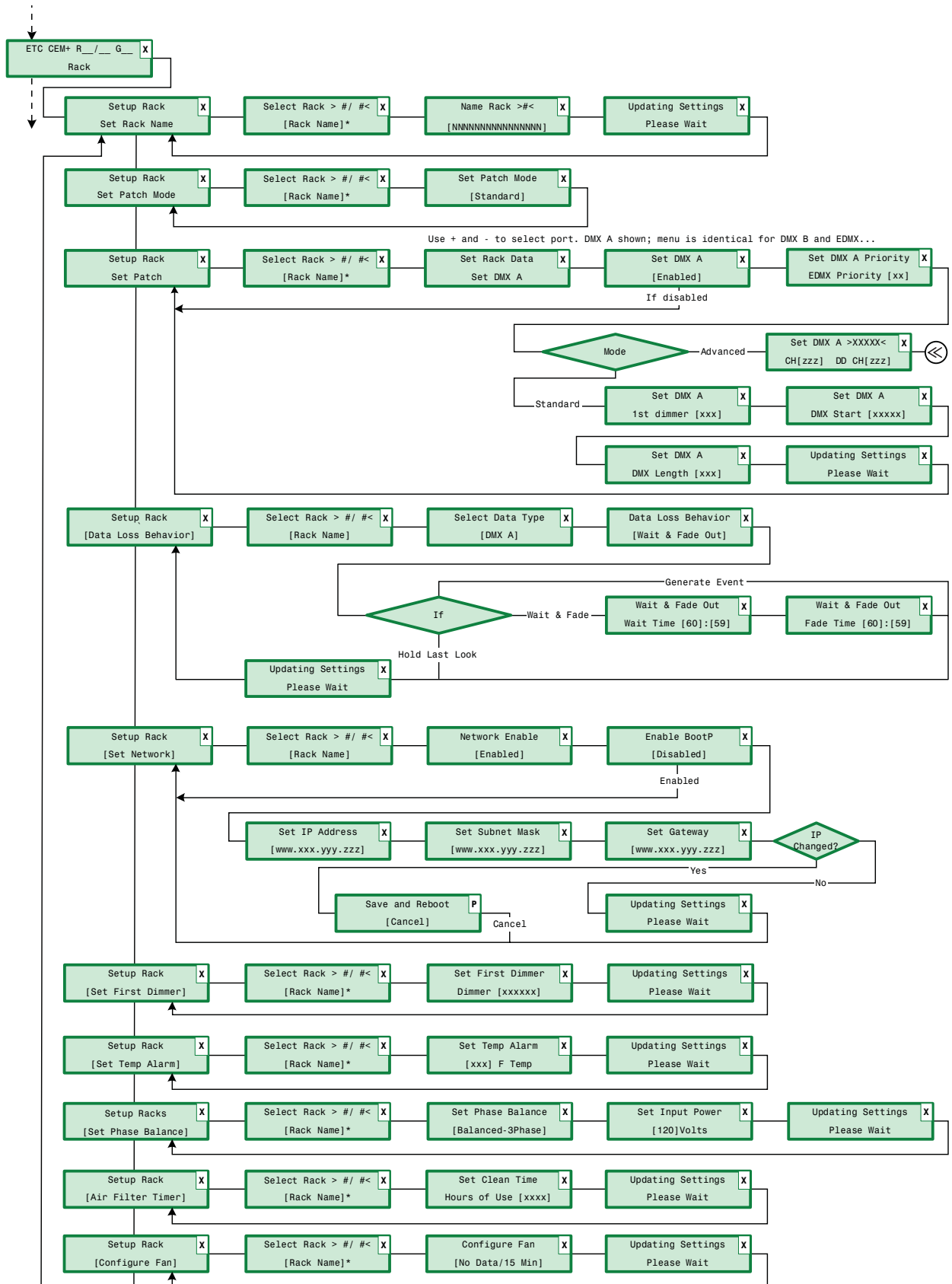

Figure 9: The Rack menu

Set Phase Balance (User only)

The Set Phase Balance menu allows a **User** to set the type of phasing used by the selected rack and the voltage of the line feed power. Available settings include: Balanced-3Phase, Balanced-1Phase, Straight-3Phase and Straight-1Phase.

- **Balanced-3Phase:** rack is fed 3-Phase power and dimmer numbers are distributed numerically by phase, rather than by rack position. Example: dimmers 1 and 2 are in the top slot of a rack; dimmers 3 and 4 are located first on the second phase, 1/3 of the way down the rack; dimmers 5 and 6 are located first on the third phase, 2/3 of the way down the rack.
- **Balanced-1Phase:** rack is fed 1-Phase power and dimmer numbers are distributed numerically by bus bar, rather than by rack position. Example: dimmers 1 and 2 are in the top slot of a rack; dimmers 3 and 4 are located first on the second bus bar, 1/2 of the way down the rack.
- **Straight3-Phase:** rack is fed 3-Phase power and dimmer numbers are distributed numerically from top to bottom in the rack. Example: dimmers 1 and 2 are in the top slot of a rack, dimmers 3 and 4 are located in the next slot, etc.
- **Straight1-Phase:** rack is fed 1-Phase power and dimmer numbers are distributed numerically from top to bottom in the rack. Example: dimmers 1 and 2 are in the top slot of a rack, dimmers 3 and 4 are located in the next slot, etc.

Air Filter Timer (User only)

The Air Filter Timer menu allows a **User** to set the amount of time between air filter cleaning reminders for a selected rack. This timer counts down only when the fan is running in the rack.

Configure Fan (User only)

The Configure Fan menu allows a **User** to configure the behavior of the fan in the selected rack. Available settings include: No Data/15 Min and Always On. No Data/15 Min will allow the fan to shut off if there have been no dimmer levels sent to that rack in 15 minutes. When levels are sent to dimmers in the rack, the fan will start up automatically. The fan will always run for 15 minutes following a reset of the CEM+.

Group (User only - no Guest access)

The Group menu includes menus for recording loads, naming the group, setting the preferred units for temperature reporting, and language and login settings. The Group menu is available only to those logged in at the **User** level.

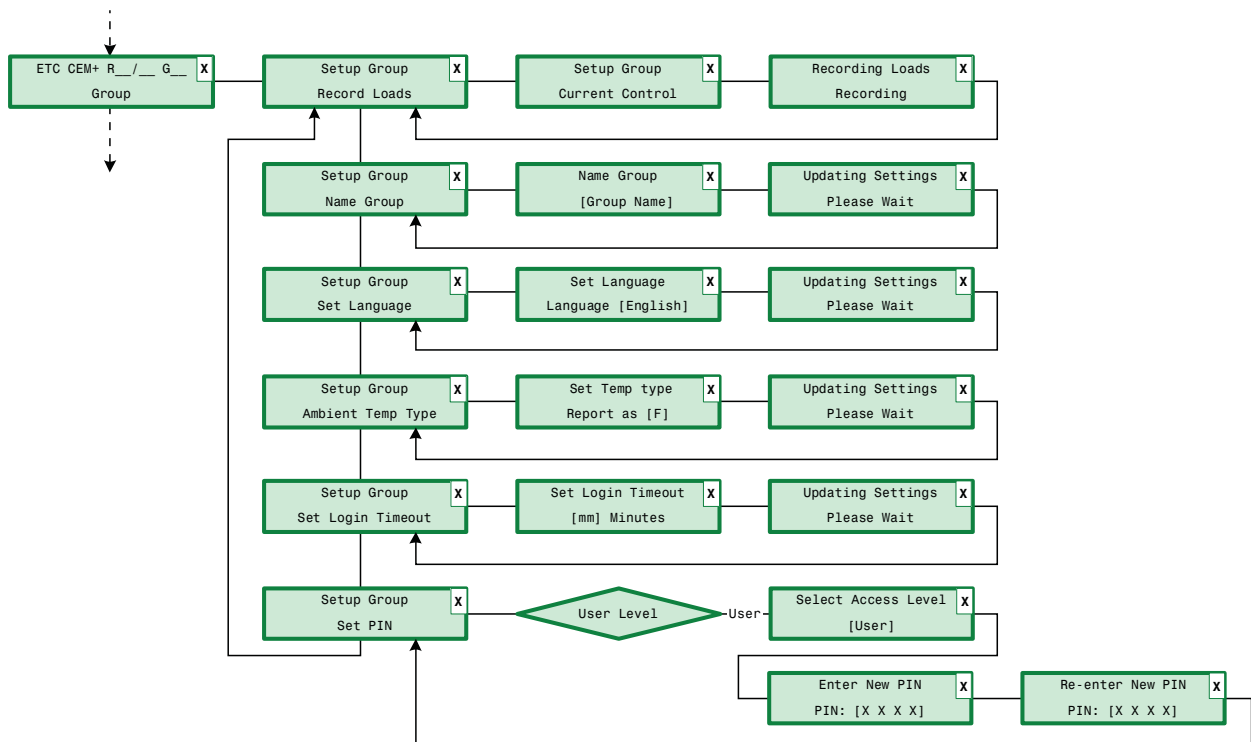

Figure 10: The Group menu

Record Loads (User only)

The Record Loads menu is used to record the loads on each dimmer. This is useful in Advanced Features systems where load reporting is desired.

Name Group (User only)

The Name Group menu allows a **User** to set the name of the Group. Names are alphanumeric and can be up to 20 characters long (not all 20 characters will be visible on the LCD).

Set Language (User only)

The Set Language menu allows a **User** to set the language of the user interface.

Ambient Temp Type (User only)

The Ambient Temp Type menu allows a **User** to set temperature reporting as either Fahrenheit or Celsius.

Set Login Timeout (User only)

The Set Login Timeout menu allows a **User** to set the time after which the CEM+ will automatically log the current user out and return to the default access level as set in the Group configuration. The timeout is based upon inactivity at the keypad.

Set PIN (User only)

The Set PIN menu allows a **User** to set the PIN for **User** level login. **Guests** require no PIN for access.

Chapter 3

Maintenance

The air filter in the door of your dimmer rack traps dust and dirt that would otherwise clog the air vents of your dimmer and CEM+ modules. This filter should be inspected regularly (every six months) and cleaned as needed. Also, the front faces of the dimmer and CEM+ modules can be vacuumed if your dimmer rack is being used in a highly dusty area.

Clean dimmer rack air filter:

- Step 1: Open the dimmer rack door. The air filter is mounted on the inside of the door, held in on the bottom by a metal lip.
- Step 2: Slide the filter up about 1 cm (1/2 inch) until the filter base clears the top edge of the lip. Pull the base out far enough to clear the retaining lip and slide the filter down and out of the door.

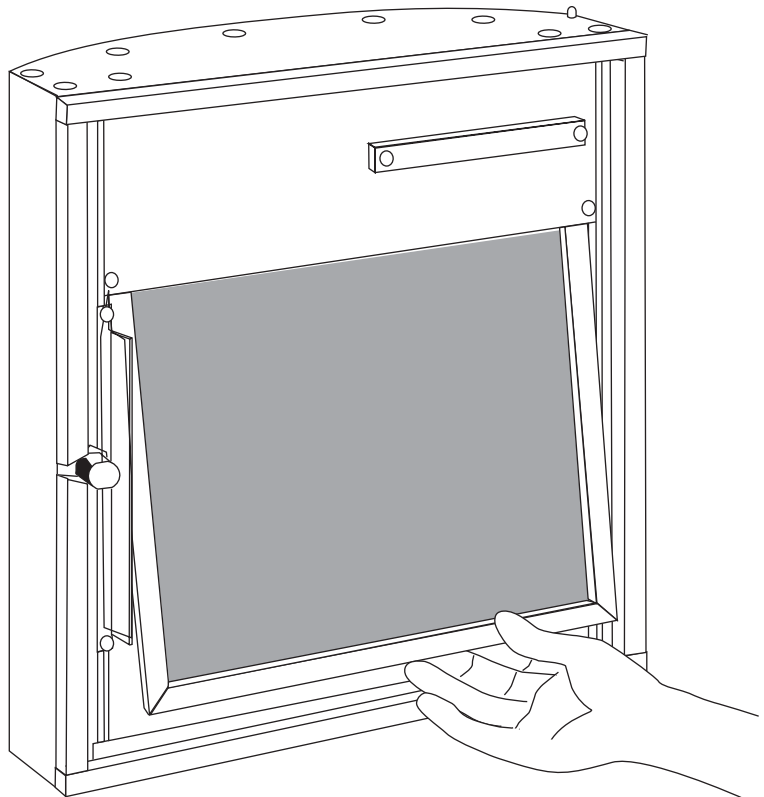



Figure 11: Removing the air filter

- Step 3: Vacuum or blow dust out of the filter AWAY FROM THE DIMMER RACK.



Note: You can wash the filter under clear tap water, but it must be completely dry before you reinstall it. Do not use soap or other chemicals to clean the filter.

- Step 4: Slide the top of the filter back up into the slot at the top of the door until the base clears the metal retaining lip on the bottom of the door.
- Step 5: Let the filter drop back into place.

Step 6: Reset the Air Filter Timer in the Rack menu. This action requires a **User** password. To keep the same Air Filter Timer interval, simply press .

Step 7: Close the rack door.

Vacuum dust from dimmer modules:



WARNING: *RISK OF ELECTRIC SHOCK! To avoid the possibility of electrical shock, turn off power at the main breaker before touching the rack with the vacuum nozzle.*

Phase voltages inside the rack can be deadly. Do not remove rack modules when vacuuming dimmer racks. Only qualified technicians should expose the inside of the dimmer rack.

Step 1: Open the door and look at the dimmer module air vents, SCR power cube air inlets and the CEM+ air vent.



Note: *Leave the modules inside the rack. Most dust collects on the dimmer module air vents and SCR power cube air inlets of the dimmer modules.*

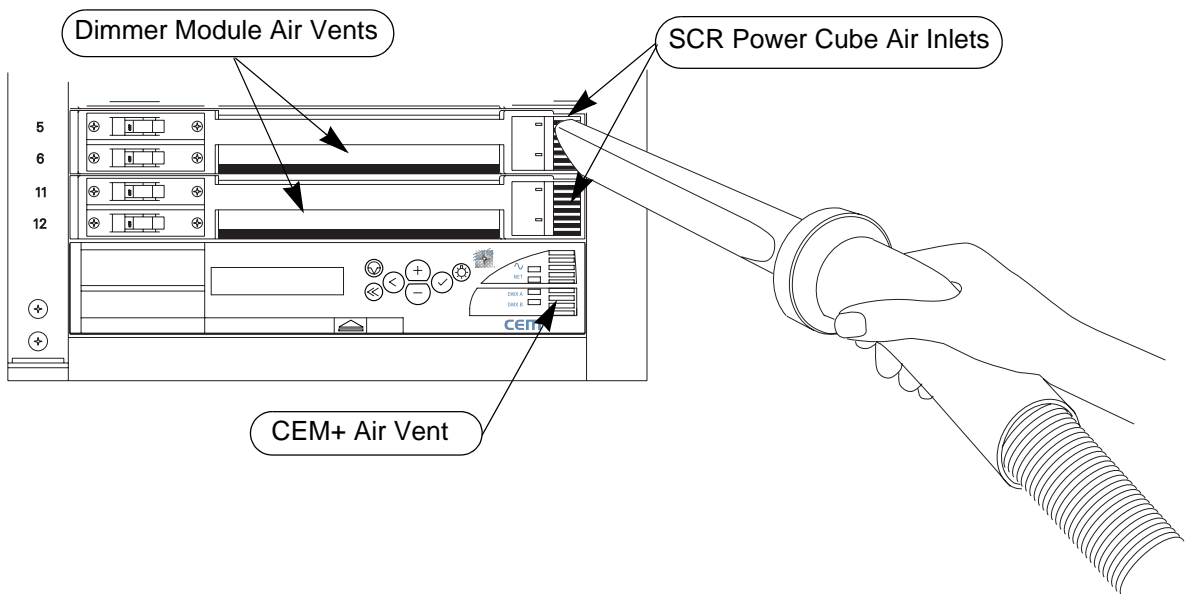

Figure 12: Vacuuming CEM+ rack modules

Step 2: If a dust buildup is visible, vacuum the front of the modules. Use a narrow vacuum cleaner nozzle to vacuum dimmer module air vents, the SCR power cube air inlets and the CEM+ air vent. Do not push debris into the modules.

Step 3: Close the rack door.

Chapter 4

Service

Contacting ETC about equipment problems

If possible, please have this information available before contacting ETC about an equipment problem:

- Your location and job name
- Any error messages on the CEM+ status LCD display
- Related system problems or equipment failures

ETC Americas: Tel: +1 800 688 4116 (toll-free within USA)
Tel: +1 608 831 4116 (from outside USA)
Email: service@etconnect.com

ETC Asia: Tel: +852 2799 1220
Email: service@etcasia.com

ETC Europe: Tel: +44 (0)20 8896 1000
Email: service@etceurope.com



Note: *For the best service results, always tell your service representative you are using the CEM+ version of Sensor dimming system.*



WARNING: *RISK OF ELECTRIC SHOCK! Servicing Sensor CEM+ dimming equipment exposes high amperage power connections inside the rack. If possible, always turn off power at the main circuit breaker before servicing your system.*

Changing Installation Rack Modules

All Sensor+ rack dimmer modules can be easily replaced without tools. Modules slide in and out of their slots and are ready to start dimming immediately.

Although Sensor modules, including the CEM+, can be replaced with power on, always turn rack power off at the main circuit breaker, if possible, before changing modules.



CAUTION: *Operating a dimmer rack with open module slots disrupts airflow inside the rack, which can lead to rack overheating and subsequent rack shutdown.*

Remove and replace a dimmer or airflow module:

- Step 1: Turn off rack power at the main breaker, if possible.
- Step 2: Open the rack door.
- Step 3: Switch the dimmer module's circuit breaker(s) to the "off" position.
- Step 4: Grasp the dimmer module by the center of the main air vent.
- Step 5: Pull the dimmer straight out.
- Step 6: Ensure the circuit breaker(s) on the replacement module are in the "off" position.

- Step 7: Insert the replacement dimmer or airflow module into the correct slot and firmly press the module into the slot until you feel the connections seat (the module face will be flush with the other modules).
- Step 8: Switch the module's circuit breaker(s) to the "on" position.
- Step 9: Close and lock the Sensor rack door before applying power.

Remove and replace a CEM+ module:

- Step 1: Turn off rack power at the main breaker.
- Step 2: Open the rack door.
- Step 3: Press the "eject" symbol on the right end of the spring-loaded handle and grab the other end of the handle, pulling it until it is perpendicular to the face of the CEM+. The CEM+ will be gently pushed out of the rack as you move the handle.

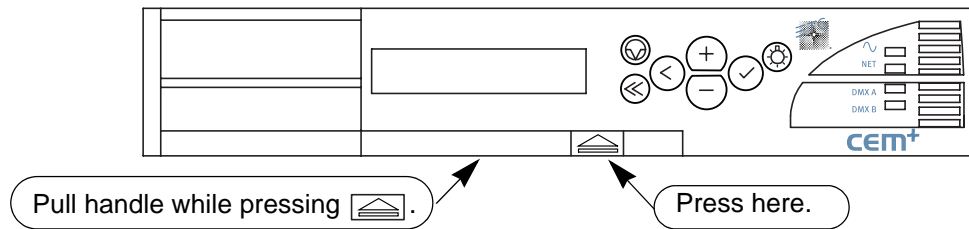

Figure 1: Removing the CEM+ module

- Step 4: Pull the CEM+ straight out.
- Step 5: Firmly press the new CEM+ module into the correct slot until you feel the connections seat (the module face will be flush with the other modules).
- Step 6: Close and lock the Sensor rack door before applying power.
- Step 7: *ONLY* if directed to do so by an ETC-authorized service representative, transfer configuration and Backup look information to your new CEM+.

Dimmer module circuit breakers

Each dimmer is protected by a built-in circuit breaker on the left side of the module. Circuit breakers are turned on and off (or reset) using the switch handles on the left side of the dimmer modules. Dual-density dimmer modules have two circuit breaker switches.

Operate module circuit breakers:

- Step 1: Open the dimmer rack door.
- Step 2: Locate the dimmer module you want to control or reset. Handles on tripped circuit breakers will be to the right.
- Step 3: Put the circuit breaker switch in the desired on or off position.
 - Push the handle **left** to turn the dimmer on or reset a tripped breaker.
 - Push the handle **right** to turn the dimmer off.

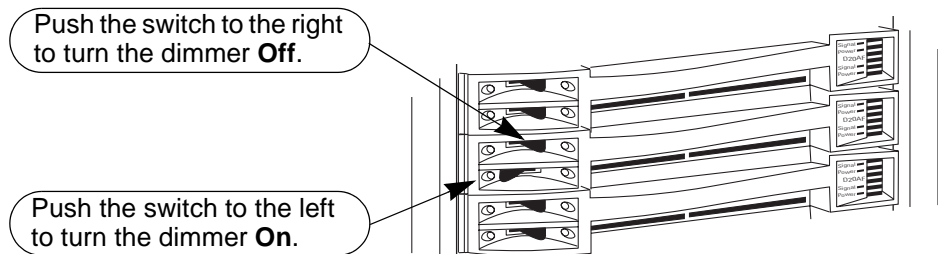

Figure 2: Dimmer module circuit breakers

CEM+ Fuses

The CEM+ has two fuses:

- The F1 fuse is a 250V, 0.75 amp, fuse. CEM+ operating power and power for the dimmer module electronics, is drawn through this fuse. If F1 fails, the CEM+ will not operate and dimming will not work. The Sensor+ rack beacon will be dark. The fuse in the F2 position is a spare 0.75 amp fuse.
- Phase F3 fuse is a 250V, 5 amp fuse. Power for the rack's fan is drawn through this fuse. If F3 fails, the fan will stop running and the CEM+ will display an air flow error. The Sensor+ rack beacon will flash to signal a problem. The rack may shut down due to overheating. The fuse in the F4 position is a spare 5 amp fuse.

Replacing a fuse:

Step 1: Remove the CEM+ module (See [Changing Installation Rack Modules, page 27](#)).

Step 2: Locate and replace the defective fuse. Fuses are held in vertical fuse holders.

- a: Use a flat-blade screwdriver to gently turn the cap of the fuse holder to the left until it comes free.
- b: Lift the cap and the fuse straight out of the fuse holder.
- c: Remove the defective fuse and replace it with a fuse of the same type. A spare fuse of each type is provided on the CEM+.
- d: Replace the fuse and cap in the fuse holder and use a flat-blade screwdriver to gently turn the cap to the right to fully capture the fuse.

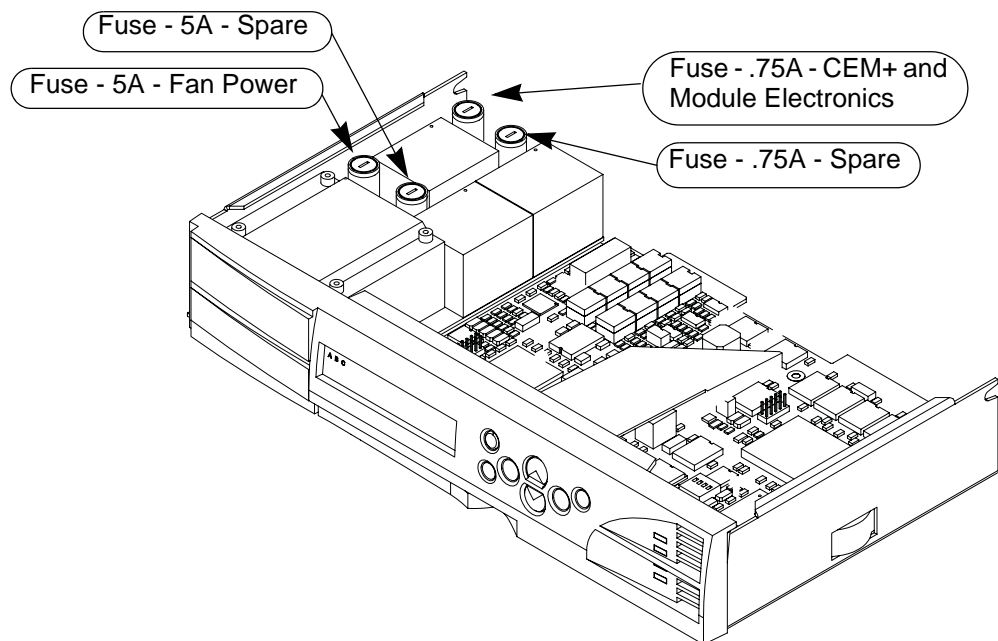

Figure 3: Replacing CEM+ fuses

Step 3: Replace the CEM+ module and close the door.

Reset/Test Ground Fault Interrupt (GFI) dimmer modules

GFI modules have circuitry that compares the current between the phase and neutral wires on the dimmer circuit. If the module detects more than a 5mA current drop (ground fault) between phase and neutral, it trips the breaker. GFI dimmer modules from ETC comply with UL 943 if they are properly installed and maintained.

Reset a tripped GFI circuit breaker:

- Step 1: Open the dimmer rack door.
- Step 2: Locate the dimmer module you want to control or reset. Dual-density dimmer modules have two circuit breaker switches. Handles on tripped circuit breakers will be to the right.
- Step 3: Put the circuit breaker switch in the desired On or Off position.
 - Push the handle **left** to turn the dimmer on or reset a tripped breaker.
 - Push the handle **right** to turn the dimmer off.

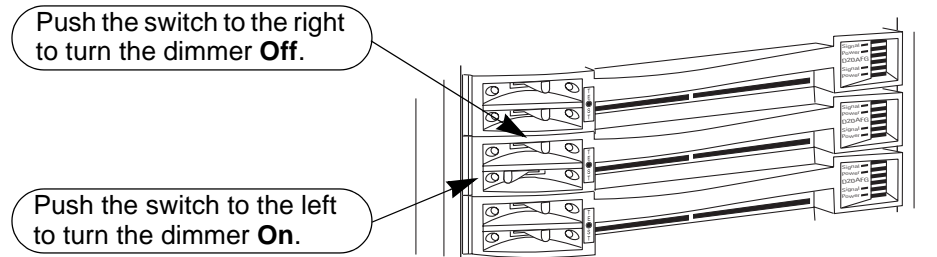

Figure 4: GFI Dimmer module circuit breakers

Testing GFI Circuit Breaker Functions

GFI dimmer modules must be tested monthly for proper GFI operation in order to comply with UL943 for life safety applications. Test results should be recorded on a test sheet that is easily accessible from the dimmer rack.



Note: GFI tests must be performed with rack power on.

Test the GFI circuit breakers:

- Step 1: Open the dimmer rack door and locate the GFI modules you want to test.
- Step 2: Push the Test switch just right of the circuit breaker handles:
 - If the GFI breaker is working, the breaker switches will trip to the right.
 - If the switches do not trip, the GFI circuit may need repair.

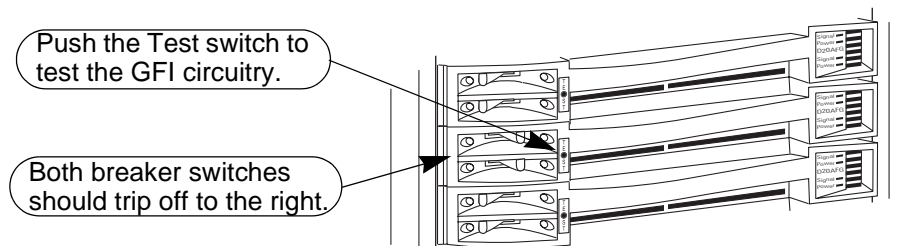

Figure 5: GFI Dimmer module circuit breakers

- Step 3: Reset the breaker switches and log the test on the test sheet.
- Step 4: Close the dimmer rack door.



WARNING: GFI testing must be performed and logged monthly to conform to UL 943 GFCI Life Safety requirements.

Troubleshooting

Your Sensor+ system helps you identify system problems with status reporting and diagnostic testing capabilities.

You will usually notice a system problem in one of two ways:

- The Sensor+ beacon on the dimmer rack begins blinking, indicating the CEM+ has detected a problem. The system may still continue to dim normally.
- You notice a problem with system performance. The beacon may be flashing, or the problem may be caused by another part of your lighting control system.

When either of these situations occur, you can follow these steps to isolate and correct the cause.

Make a preliminary examination of your system...

- Check the CEM+ display, Sensor+ Connect or WYSILink for error messages. For an explanation of error message causes and possible corrections, see [CEM+ Error Messages, page 33](#).

If lights are stuck on...

- Check for an activated Preset at your CEM+. (This can lock some or all of your dimmer circuits at one level.)
- Make sure your Panic circuit is not activated. (This will drive some of your dimmer circuit to full and hold them there.)
- Make sure all direct dimmer levels at the CEM+ are cleared. (This can lock some or all of your dimmer circuits at one level.)

If lights won't come on...

- Look for obstructions on top or in front of your installation rack that may be blocking rack ventilation.
- Open the door and look for dust buildup on the air filter or rack modules.
- Check for tripped dimmer module circuit breakers.
- Check for tripped breakers on your main circuit breaker panel.
- Check for loose or damaged control cables coming into your dimmer rack.

When you think you've found the problem...

- Correct any of these problems you find, press the reset button  on the front of the CEM+ module and observe the system to see if the problem still exists.

If you cannot locate or correct the problem...

If you are unable to eliminate the problem, contact your authorized ETC representative.

See [Contacting ETC about equipment problems, page 27](#), for procedures on contacting ETC for technical help.

Appendix A

CEM+ Error Messages



If the CEM+ detects an error, it will flash the beacon and display the appropriate error message on the LCD display. A CEM+ will only display error messages for the same rack it is in - you can't browse to other racks to view their errors from a single CEM+.

Errors are also displayed in the WYSILink Message Log on Emphasis Control Systems and WYSILink PCs on the network. You can also view rack error messages in the Sensor+ Connect interface on Emphasis Control Systems or by browsing into a CEM+ using Internet Explorer 6 on a PC on the network.

View error messages on the CEM+ LCD display:

Step 1: Open the door of the rack with the blinking beacon. The CEM+ will display the message [Rack Errors].

Step 2: Press  to enter the error list. The number of errors and which error is currently displayed of that number are displayed at the top of the display.

Step 3: Press  and  to increment and decrement through the list, if necessary.

CEM+ Error Message	Probable Cause	Possible Corrective Action
AMBIENT OVERTEMP	Ambient temperature is higher than 115°F (46°C).	Lower dimmer room temperature.
AMBIENT TEMP HIGH	Ambient temperature is higher than 104°F (40°C).	Lower dimmer room temperature.
AMBIENT TEMP LOW	Ambient temperature is lower than 32°F (0°).	Raise dimmer room temperature.
DIMMER ERROR	A dimmer in this rack has an error.	Use About Dimmer to check the specific error.
DATA ERROR PORT (A or B)	DMX512 data error	Check DMX512 port input cable and termination.
FREQUENCY ERROR	Feed power is not 50 or 60Hz. (±2.5Hz)	Check input frequency.
NO AIRFLOW	Insufficient airflow detected.	Check fan and air filter for obstruction.
NO DATA PORT (A or B)	No DMX512 data has been received by Port (A or B).	Check DMX512 source devices and input cables.
MODULE __ OVERTEMP	Dimmer module has overheated and shut down.	Check airflow
PHASE (A, B or C) OFF	No voltage on phase (A, B or C).	Check line feed.
PHASE DETECT FAIL	CEM+ could not read the line feed phasing.	Re-seat the CEM+ and try again. If problem persists, replace the CEM+.
TEMP SENSOR STUCK	Ambient temperature sensor is stuck.	Replace CEM+.
ZERO CROSS ERROR	CEM+ hardware failure.	Replace CEM+.
SOFTWARE ERROR	CEM+ units running different versions of software are on the same network.	Install the same version of software on all CEM+ units.
PHASE (A, B or C) VOLTS HIGH	Voltage on phase (A, B or C) is higher than 140Vac.	Check line feed.

CEM+ Error Message	Probable Cause	Possible Corrective Action
PHASE (A, B or C) VOLTS LOW	Voltage on phase (A, B or C) is lower than 80Vac.	Check line feed.
LOW AIRFLOW	Airflow is low.	Check fans and air filter for obstruction.
CLEAN YOUR FILTER	This is a reminder to clean your air filter. It appears when the "Clean Time" clock has counted down to zero.	Reset the "Clean Time" counter to the number of hours you want between filter cleaning.
PHASE (A, B or C) HEADROOM	Incoming line voltage on phase (A, B or C) has dipped below the configuration-defined Headroom level.	Reduce the load on the indicated phase through repatching or lowering output levels of associated dimmers.
CONFIG MISMATCH __	Configuration error.	Transfer configuration data from another rack.
BREAKER __ TRIP	The circuit breaker on dimmer __ has tripped.	Check circuit for cause of circuit breaker trip, such as too many lamps on the dimmer, or bad cabling.
SCR __ STUCK ON	The SCR in dimmer __ has failed on.	Replace dimmer module.
SCR __ STUCK OFF	The SCR in dimmer __ has failed off.	Replace dimmer module.
RCD __ TRIP	The RCD in __ has failed tripped.	Replace RCD module.
MODULE __ REMOVED	Module has been removed from the rack.	Reinsert or replace module.
LOAD __ CHANGE HIGH	Load is currently higher than the recorded load for this dimmer.	Rerecord the load, or check for additional or higher wattage lamp(s) on the circuit.
LOAD __ CHANGE LOW	Load is currently lower than the recorded load for this dimmer.	Rerecord the load, or check for missing or burned-out lamp(s) on the circuit.
LOAD __ NO LOAD	A load is recorded, but there is currently no load present on this dimmer.	Rerecord the load, or check for missing or burned-out lamp(s) on the circuit.

Appendix B

Dimmer Curves

Dimmer curves determine how dimmers set voltage output in response to control signal input. To accommodate designer preferences and load response variations, Sensor offers five dimmer curve choices, which can be applied to individual dimmers.

Linear curve

The linear curve matches the control input percentage to Root Mean Squared (RMS) voltage output. Each percent increase in control level increases dimmer voltage output by the same amount

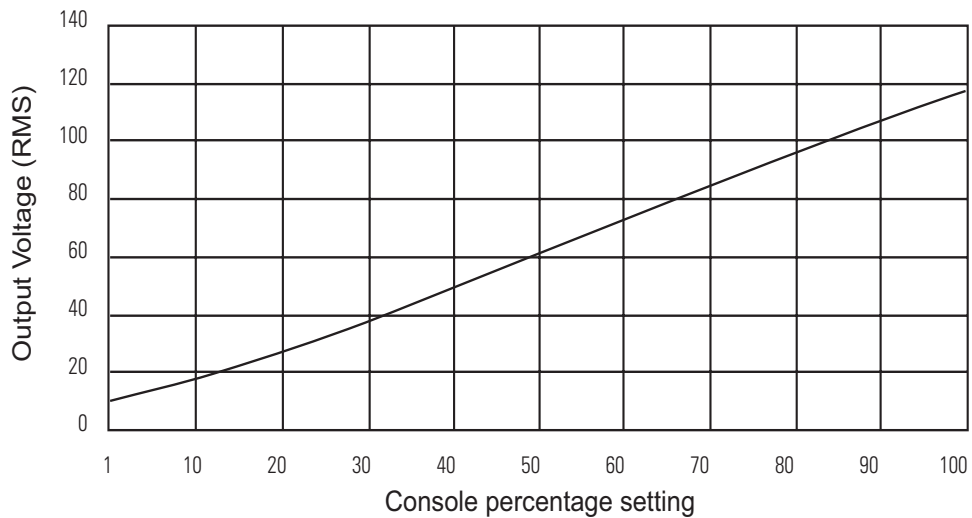

Figure 6: Linear dimmer curve



Modified linear curve

A modified linear curve reduces the voltage change at low control levels for better performance in low-wattage fixtures.

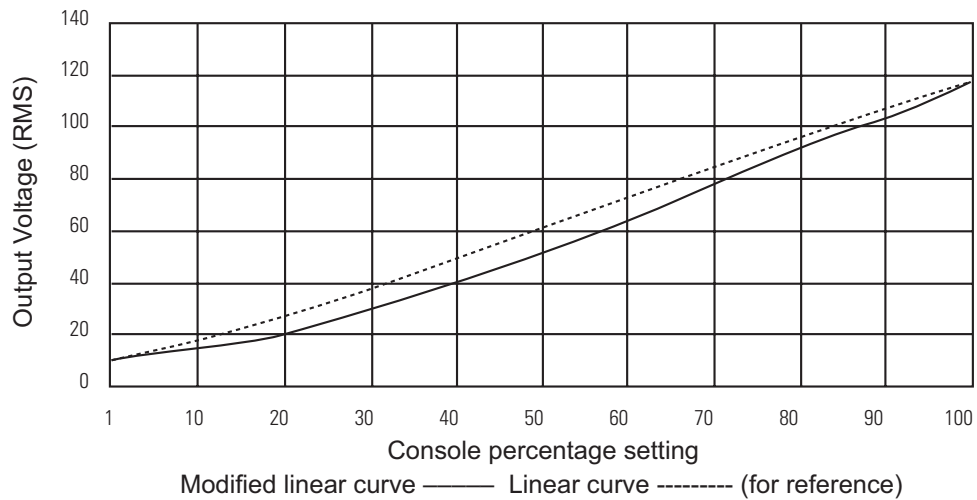

Figure 7: Modified linear dimmer curve

Square law curve

At low control levels, much of traditional incandescent fixture's light output is in the invisible infrared spectrum. This results in poor visible response to low control levels. A square law curve applies a multiple derived from the square root of the control level (with full output equal to 1.00) to increase voltage response at low control levels to compensate for the infrared loss.

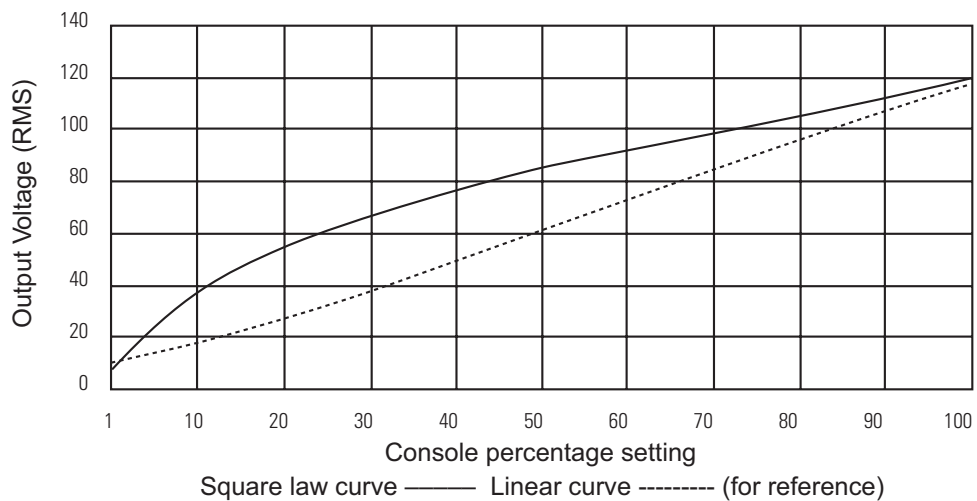

Figure 8: Square law dimmer curve

Modified Square law curve

A standard square law curve may overcompensate for infrared loss, resulting in “steppy” response to incremental control changes at low levels. ETC’s modified square law curve applies a second multiple to the standard square law curve for more uniform response to control levels changes across the entire range of dimmer output,

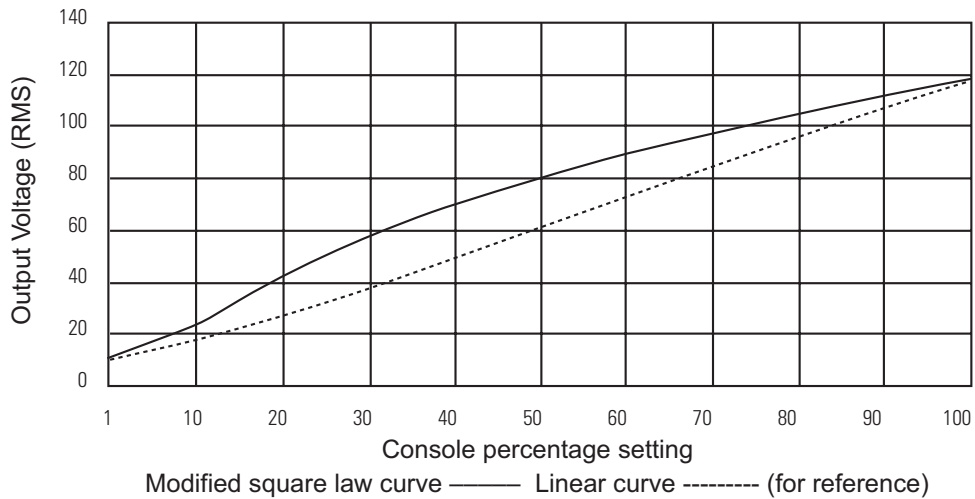

Figure 9: Modified square law dimmer curve

Sensor 2.0 curve

The Sensor 2.0 curve is the previous version of ETC’s modified square law curve. It provides backwards compatibility for shows created using earlier versions of ETC equipment and familiar response for designers who prefer the earlier version.

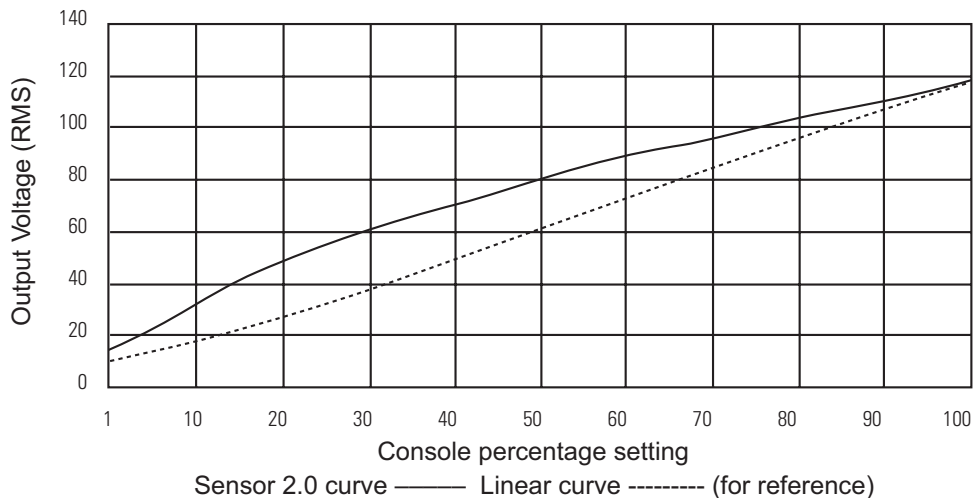

Figure 10: Sensor 2.0 dimmer curve



Appendix C

GFI Dimmer Test Sheet

Test Reminder: For maximum protection against electrical shock, operate the **Test** switch on each GFI dimmer module at least once a month. Record the test date below using a fine-point indelible ink marker.

1	37	73	109	145
2	38	74	110	146
3	39	75	111	147
4	40	76	112	148
5	41	77	113	149
6	42	78	114	150
7	43	79	115	151
8	44	80	116	152
9	45	81	117	153
10	46	82	118	154
11	47	83	119	155
12	48	84	120	156
13	49	85	121	157
14	50	86	122	158
15	51	87	123	159
16	52	88	124	160
17	53	89	125	161
18	54	90	126	162
19	55	91	127	163
20	56	92	128	164
21	57	93	129	165
22	58	94	130	166
23	59	95	131	167
24	60	96	132	168
25	61	97	133	169
26	62	98	134	170
27	63	99	135	171
28	64	100	136	172
29	65	101	137	173
30	66	102	138	174
31	67	103	139	175
32	68	104	140	176
33	69	105	141	177
34	70	106	142	178
35	71	107	143	179
36	72	108	144	180

This test log must be posted in a conspicuous location near the GFI dimmers.



Index

A

Advanced Features	6
Advanced patch	20
Air filter cleaning	25
Air filter timer	22

C

CEM+ Control Module	3
Replacement	28
User interface	7
View errors	33
Crossfade to	20

D

Data loss behavior	20
DC output prevent	19
Dimmer check	19
Dimmer Doubling	6
Dimmer menu	17
Dimmers	4
GFI modules	29
Dynamic preheat	19

E

Error messages	33
----------------------	----

F

Fan configuration	22
Feedback	6
Firing mode	18
First dimmer	20
Fuses	29

G

GFI dimmer modules	29
Testing	30
Group	3
Group menu	23

H

Hold last look	20
----------------------	----

I

Inrush protection	19
-------------------------	----

L

Login menu	13
------------------	----

M

Menus	
Dimmer	17
Group	23
Login	13
Main	10
Panic	16
Presets	14
Rack	20
Modules	4
GFI dimmers	29

P

Panic menu	16
Patch modes	20
Presets	6
Presets menu	14

R

Rack menu	20
Record loads	23
Replace a CEM+	28
Replace fuses	29

S

Sensor+ Connect	6, 8
Standard patch	20
Swap modules	27

T

Technical Services	27
Test GFI dimmers	30
Threshold	18

V

Voltage regulation	18
--------------------------	----

W

Wait & fade	20
WYSILink	6



Americas ■ 3031 Pleasant View Road, P.O. Box 620979, Middleton, Wisconsin 53562-0979 USA ■ Tel: +1 608 831 4116 ■ 800 688 4116 ■ Fax: +1 608 836 1736 ■ 800 555 8912
Europe ■ Unit 5, Victoria Industrial Estate, Victoria Road, London W3 6JU, UK ■ Tel: +44 (0)20 8896 1000 ■ Fax: +44 (0)20 8896 2000
Asia ■ Room 605-606, Tower III Enterprise Square, 9 Sheung Yuet Road, Kowloon Bay, Kowloon, Hong Kong ■ Tel: +852 2799 1220 ■ Fax: +852 2799 9325
Web: www.etconnect.com ■ Email: (US) mail@etconnect.com ■ (UK) mail@etceurope.com ■ (Asia) mail@etcasia.com
Service: service@etconnect.com ■ Toll free: 800 775 4382 ■ Comments about this document: techcomm@etconnect.com

7150M1200-1.0.x ■ Rev A ■ Released 06/2004 ■ Copyright © 2004 Electronic Theatre Controls, Inc. All Rights Reserved. Product information and specifications subject to change.